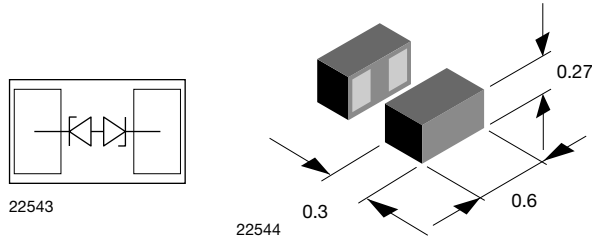


# Bidirectional Symmetrical (BiSy) Single Line ESD-Protection Diode in Silicon Package



## FEATURES

- Ultra compact CLP0603 package
- Low package height < 0.3 mm
- 1-line ESD-protection
- Working range  $\pm 5.5$  V
- Low leakage current < 0.1  $\mu$ A
- Low load capacitance  $C_D = 10$  pF
- ESD-protection acc. IEC 61000-4-2  
 $\pm 30$  kV contact discharge  
 $\pm 30$  kV air discharge
- Lead plating: Au (e4)
- Lead material: TiNiAg
- Compliant to RoHS Directive 2002/95/EC and in accordance to WEEE 2002/96/EC



## MARKING (example only)



1 = Year code

Open circle = Month code and pin 1

XY = Type code

## Note

\*\* Please see document "Vishay Material Category Policy":  
[www.vishay.com/doc?99902](http://www.vishay.com/doc?99902)

ORDERING INFORMATION			
DEVICE NAME	ORDERING CODE	TAPED UNITS PER REEL (8 mm TAPE ON 7" REEL)	MINIMUM ORDER QUANTITY
VCUT05D1-SD0	VCUT05D1-SD0-G4-08	15 000	15 000

PACKAGE DATA						
DEVICE NAME	PACKAGE NAME	TYPE CODE	WEIGHT	MOLDING COMPOUND FLAMMABILITY RATING	MOISTURE SENSITIVITY LEVEL	SOLDERING CONDITIONS
VCUT05D1-SD0	CLP0603	D1	0.12 mg	UL 94 V-0	MSL level 1 (according J-STD-020)	260 °C/10 s at terminals Reflow soldering according JEDEC STD-020

ABSOLUTE MAXIMUM RATINGS					
PARAMETER	TEST CONDITIONS		SYMBOL	VALUE	UNIT
Peak pulse current	acc. IEC 61000-4-5, 8/20 $\mu$ s/single shot		$I_{PPM}$	6	A
Peak pulse power	Pin 1 to pin 2 acc. IEC 61000-4-5; $t_p = 8/20$ $\mu$ s; single shot		$P_{PP}$	78	W
ESD immunity	Contact discharge acc. IEC61000-4-2; 10 pulses		$V_{ESD}$	$\pm 30$	kV
	Air discharge acc. IEC61000-4-2; 10 pulses			$\pm 30$	
Operating temperature	Junction temperature		$T_J$	- 55 to + 145	°C
Storage temperature			$T_{stg}$	- 55 to + 150	°C

**CUT THE SPIKES WITH VCUT05D1-SD0**

The VCUT05D1-SD0 is a Bidirectional and Symmetrical (BiSy) ESD-protection device which clamps positive and negative overvoltage transients to ground. Connected between the signal or data line and the ground the VCUT05D1-SD0 offers a high isolation (low leakage current, low capacitance) within the specified working range. Due to the short leads and small package size of the tiny CLP0603 package the line inductance is very low, so that fast transients like and ESD-strike can be clamped with minimal over- or undershoots.

ELECTRICAL CHARACTERISTICS ( $T_{amb} = 25\text{ }^{\circ}\text{C}$ , unless otherwise specified)						
PARAMETER	TEST CONDITIONS/REMARKS	SYMBOL	MIN.	TYP.	MAX.	UNIT
Protection paths	Number of lines which can be protected	$N_{channel}$	-	-	1	lines
Reverse stand-off voltage		$V_{RWM}$	-	-	5.5	V
Reverse voltage	at $I = 0.1\text{ }\mu\text{A}$	$V_R$	5.5	7.5	8.5	V
Reverse current	at $V = 5.5\text{ V}$	$I_R$	-	-	0.1	$\mu\text{A}$
Reverse breakdown voltage	at $I = 1\text{ mA}$	$V_{BR}$	6.5	8	9	V
Reverse clamping voltage	at $I_{PP} = 1\text{ A}$	$V_C$	-	8.8	10	V
	at $I_{PP} = I_{PPM} = 6\text{ A}$	$V_C$	-	11	13	V
Capacitance	at $V = 0\text{ V}$ ; $f = 1\text{ MHz}$	$C_D$	-	10	13	pF
	at $V = 2.5\text{ V}$ ; $f = 1\text{ MHz}$	$C_D$	-	8.5	-	pF

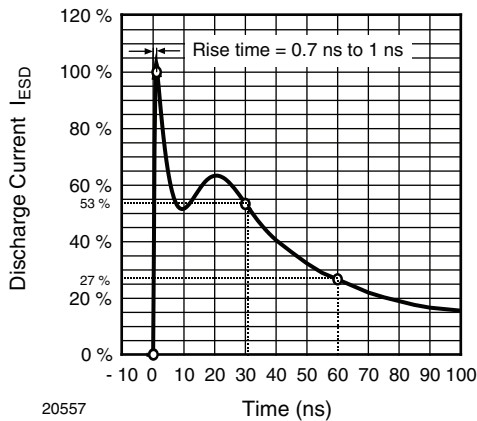
**TYPICAL CHARACTERISTICS ( $T_{amb} = 25\text{ }^{\circ}\text{C}$ , unless otherwise specified)**


Fig. 1 - ESD Discharge Current Wave Form  
acc. IEC 61000-4-2 (330  $\Omega$ /150 pF)

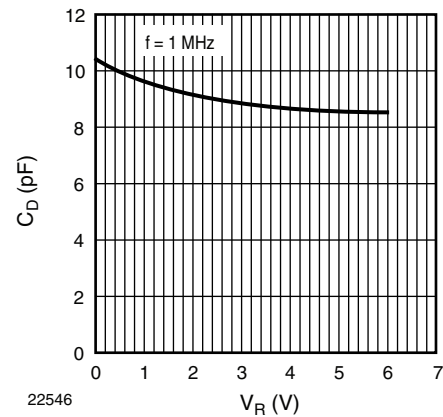


Fig. 3 - Typical Capacitance  $C_D$  vs. Reverse Voltage  $V_R$

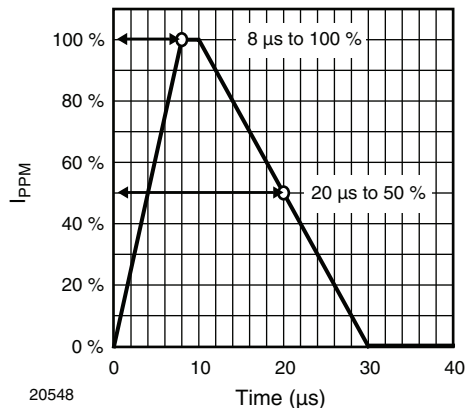


Fig. 2 - 8/20  $\mu\text{s}$  Peak Pulse Current Wave Form  
acc. IEC 61000-4-5

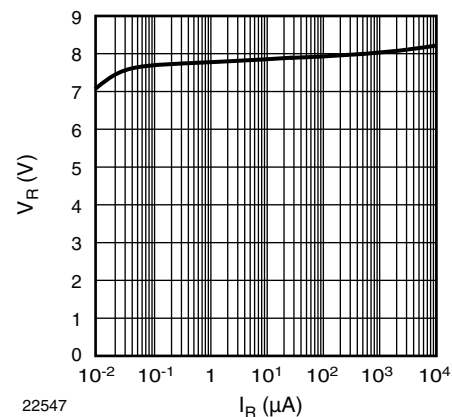
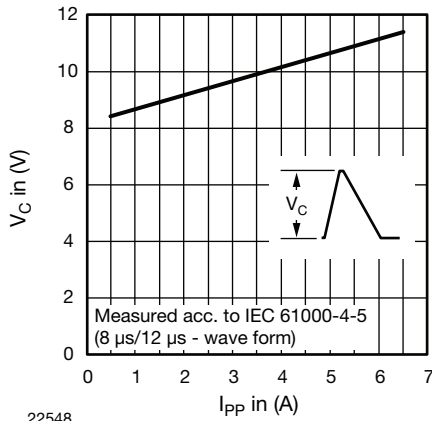
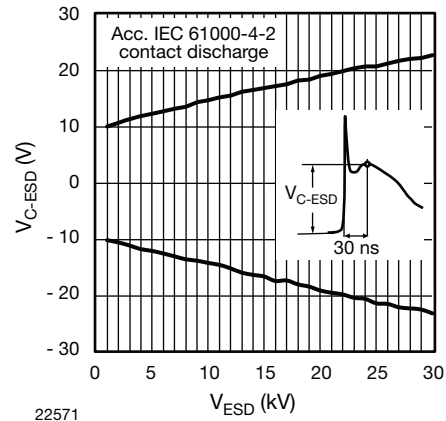


Fig. 4 - Typical Reverse Voltage  $V_R$  vs. Reverse Current  $I_R$



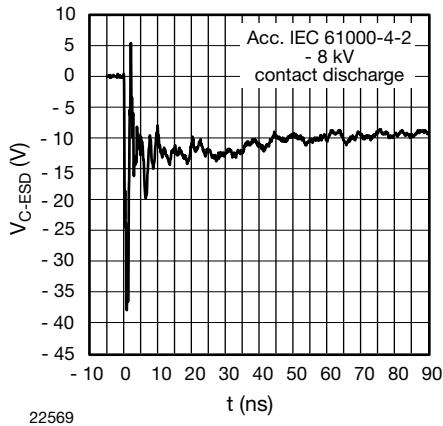
22548

Fig. 5 - Typical Peak Clamping Voltage  $V_C$  vs. Peak Pulse Current  $I_{PP}$



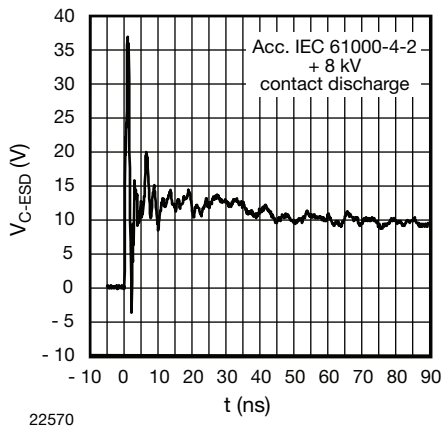
22571

Fig. 8 - Typical Clamping Performance at 8 kV Contact Discharge acc. IEC 61000-4-2



22569

Fig. 6 - Typical Clamping Performance at 8 kV Contact Discharge acc. IEC 61000-4-2

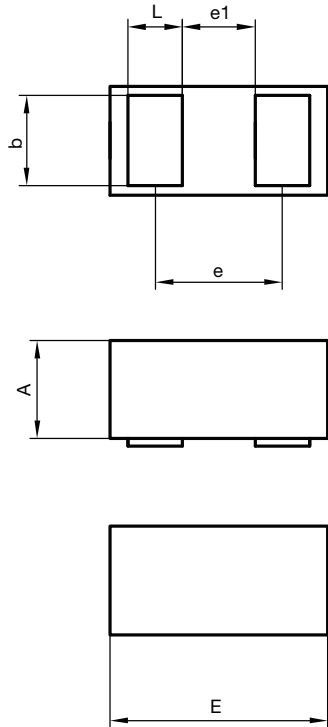


22570

Fig. 7 - Typical Clamping Performance at 8 kV Contact Discharge acc. IEC 61000-4-2



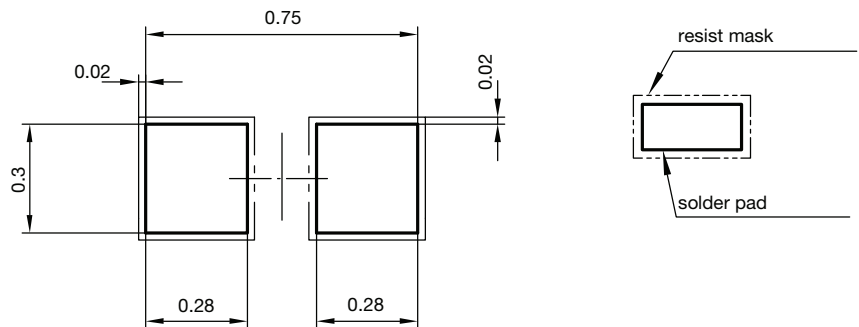
**PACKAGE DIMENSIONS** in millimeters (mils): **CLP0603-2L**



Package = Chip Dimensions in mm

	Millimeters			mils		
	min.	nom.	max.	min.	nom.	max.
A	0.24	0.27	0.30	9.44	10.63	11.81
A1			0.02			0.79
b	0.22	0.25	0.28	8.66	9.84	11.02
D	0.27	0.30	0.33	10.62	11.81	12.99
E	0.57	0.60	0.63	22.44	23.62	24.80
e		0.40			15.75	
e1		0.25			9.84	
L	0.12	0.15	0.18	4.72	5.91	7.09

foot print recommendation:

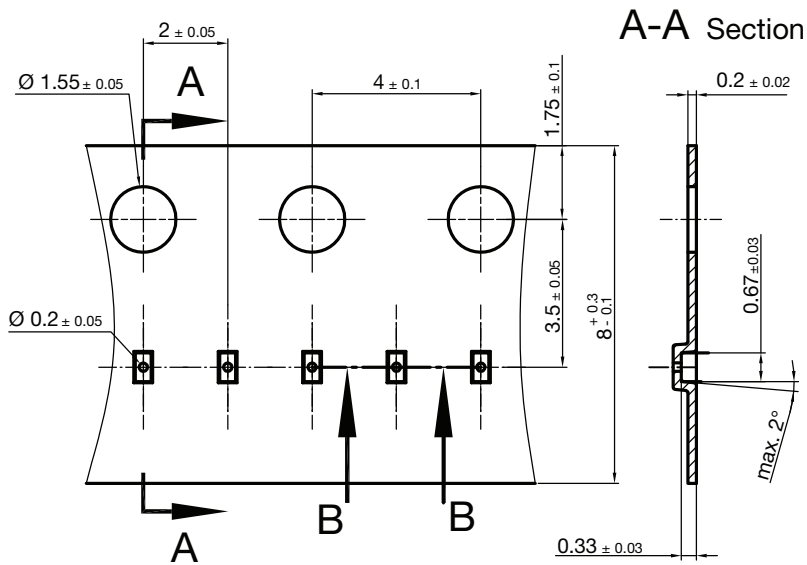


22590

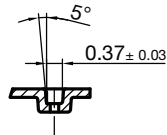
2 terminal silicon package (SI0603)  
 Document no.: S8-V-3906.04-023 (4)  
 Created - Date: 22. Nov. 2010  
 Rev.2 - Date: 03. Aug. 2011



**CARRIER TAPE** in millimeters: **CLP0603**



**B-B Section**



Cummulative tolerances of 10 sprocket holes is +/-0.2 mm

22591

Carrier tape Si0603  
Document no. S8-V-3906.04-0025 (4)  
Created - Date: 22. Nov. 2010



## Disclaimer

ALL PRODUCT, PRODUCT SPECIFICATIONS AND DATA ARE SUBJECT TO CHANGE WITHOUT NOTICE TO IMPROVE RELIABILITY, FUNCTION OR DESIGN OR OTHERWISE.

Vishay Intertechnology, Inc., its affiliates, agents, and employees, and all persons acting on its or their behalf (collectively, "Vishay"), disclaim any and all liability for any errors, inaccuracies or incompleteness contained in any datasheet or in any other disclosure relating to any product.

Vishay makes no warranty, representation or guarantee regarding the suitability of the products for any particular purpose or the continuing production of any product. To the maximum extent permitted by applicable law, Vishay disclaims (i) any and all liability arising out of the application or use of any product, (ii) any and all liability, including without limitation special, consequential or incidental damages, and (iii) any and all implied warranties, including warranties of fitness for particular purpose, non-infringement and merchantability.

Statements regarding the suitability of products for certain types of applications are based on Vishay's knowledge of typical requirements that are often placed on Vishay products in generic applications. Such statements are not binding statements about the suitability of products for a particular application. It is the customer's responsibility to validate that a particular product with the properties described in the product specification is suitable for use in a particular application. Parameters provided in datasheets and/or specifications may vary in different applications and performance may vary over time. All operating parameters, including typical parameters, must be validated for each customer application by the customer's technical experts. Product specifications do not expand or otherwise modify Vishay's terms and conditions of purchase, including but not limited to the warranty expressed therein.

Except as expressly indicated in writing, Vishay products are not designed for use in medical, life-saving, or life-sustaining applications or for any other application in which the failure of the Vishay product could result in personal injury or death. Customers using or selling Vishay products not expressly indicated for use in such applications do so at their own risk and agree to fully indemnify and hold Vishay and its distributors harmless from and against any and all claims, liabilities, expenses and damages arising or resulting in connection with such use or sale, including attorneys fees, even if such claim alleges that Vishay or its distributor was negligent regarding the design or manufacture of the part. Please contact authorized Vishay personnel to obtain written terms and conditions regarding products designed for such applications.

No license, express or implied, by estoppel or otherwise, to any intellectual property rights is granted by this document or by any conduct of Vishay. Product names and markings noted herein may be trademarks of their respective owners.